

The **LPL5 Giza**, named after the City of Pyramids, features a bold upright posture with craftsmanship worthy of its pedigree. Protected inside is our exclusive Cree® powered Copper Core®, Thermally Integrated® LED light engine. By night, light exudes from under the heavy cast bronze louver delivering glare-free illumination. Giza: bold styling, superior materials, mechanical innovation; pure engineering-bliss.

Features include:

- 6 Watts, up to 224 Lumens at 2700K
- Cree LED™ XP-L® High Density
- Precision Machined Acrylic Optic
- 2700K (80 & 90 CRI), 3000K (80 CRI), 4500K (80 CRI) or Amber 585-595nm
- Thermally Integrated® w/ Copper Core Technology®
- 12V Integral Constant Current Driver AC or DC Input
- Dimmable to <10% (TRIAC/Forward Phase)
- Compatible w/ 12V AC/DC MLV or ELV Transformers
- Solid Copper and Brass Construction
- Contact Factory for Custom Height



LPL5-SQ-BLP

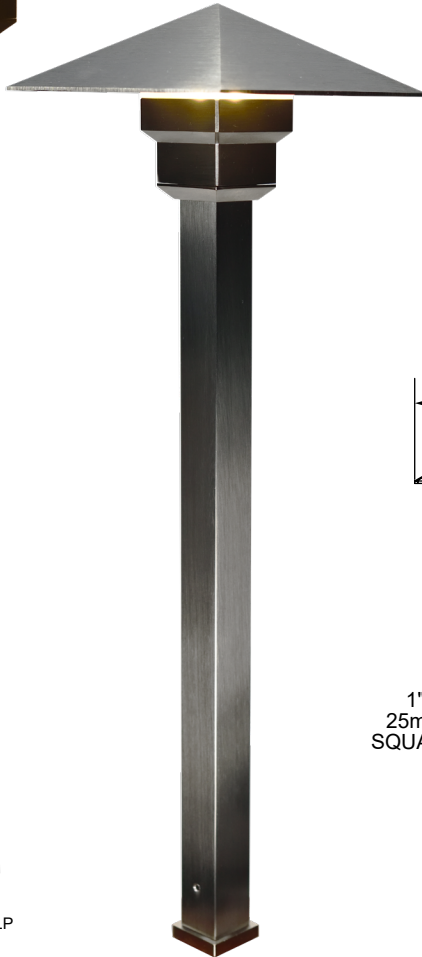

LPL5-SQ-NI

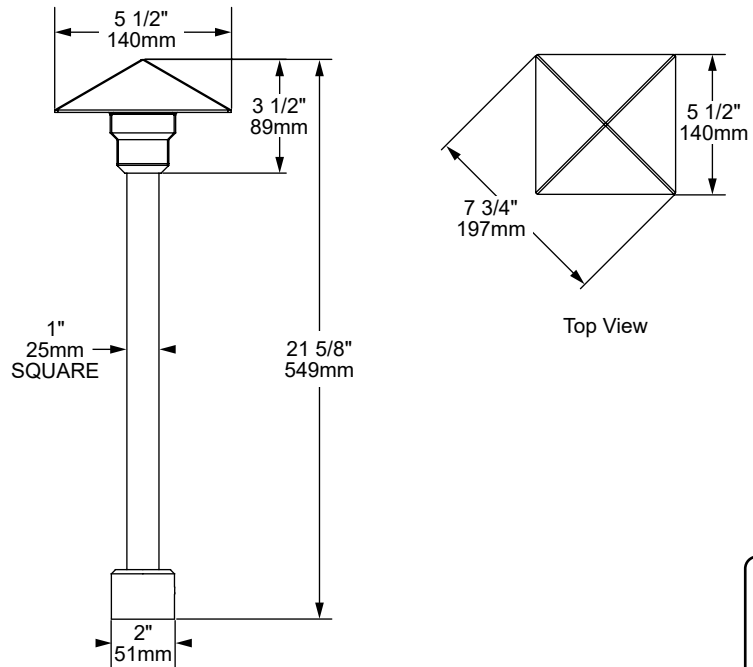

COPPER CORE TECHNOLOGY®

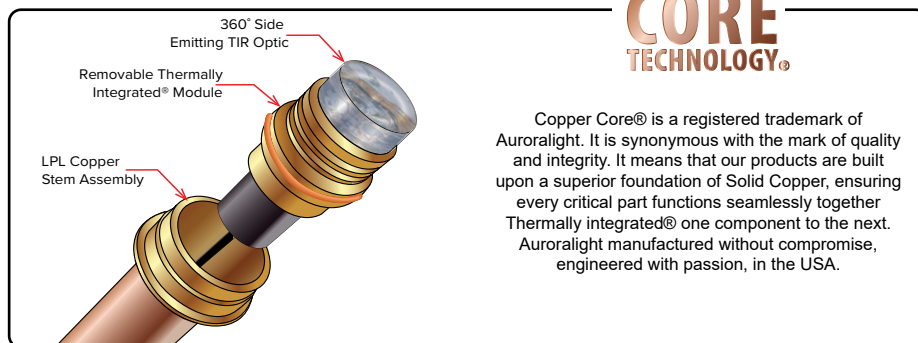

Copper Core® is a registered trademark of Auroralight. It is synonymous with the mark of quality and integrity. It means that our products are built upon a superior foundation of Solid Copper, ensuring every critical part functions seamlessly together Thermally integrated® one component to the next. Auroralight manufactured without compromise, engineered with passion, in the USA.

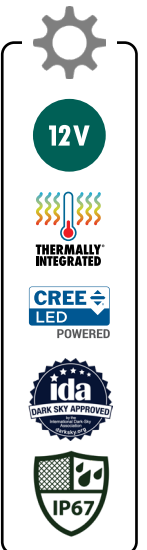

SEE NEXT PAGE FOR ORDERING INFORMATION

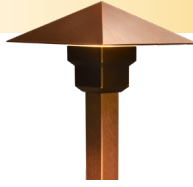

ORDERING GUIDE: ^{Prefix} **LPL5-SQ** L (LED) PL (PATH LIGHT) 5 (INCHES) SQ (SQUARE)

☐ INDICATES REQUIRED FIELD ☐ INDICATES OPTIONAL FIELD ✓ INCLUDED IN BASE PRICE [_] QUICK SPEC (See Below)

QUICK SPEC SKU **LPL5-SQ-27-2GS-NAT**

LPL5-SQ					
	<p>LED COLOR ✓</p> <p>[27] 2700K, 80CRI</p> <p>[279] 2700K, 90CRI</p> <p>[30] 3000K, 80CRI</p> <p>[45] 4500K, 80 CRI</p> <p>[AMB] Amber (585-595nm)</p> <p>NOTE: For other CCT and CRI options, contact factory. CCT 3000K or less required for Dark Sky compliance.</p>	<p>ACCESSORIES</p> <p>[180] 180° Shield</p>	<p>MOUNT</p> <p>NO MOUNT:</p> <p>[1/2] 1/2" Male Thread</p> <p>GROUND:</p> <p>[2GS] Ground Stake w 2" Cap ✓</p> <p>[3GS] Ground Stake w 3" Cap</p> <p>[325GS] Ground Stake w 3 1/4" Cap</p> <p>[DS] Deluxe Spike 9"</p> <p>[TR-12] Trident Spike</p> <p>[JB3-S] 3" J-Box w/ Stake</p> <p>[PB-S] Power Box w/ Stake (Inc. 60W 120-12V trans.)</p> <p>[PM-60] 4" Pedestal Mount</p> <p>SURFACE:</p> <p>[SM2] 2 1/4" Surface Mount</p> <p>[SM3] 3 1/4" Surface Mount</p>	<p>FINISH</p> <p>STANDARD:</p> <p>[NAT] Natural ✓</p> <p>PLUS (\$):</p> <p>[BLP] Bronze Living Patina</p> <p>[BLP-XD] BLP Extra Dark</p> <p>PREMIUM (\$\$\$):</p> <p>[NI] Nickel PVD</p> <p>[BG] Black Gloss PVD</p> <p>[BS] Black Satin PVD</p> <p>[BZ] Bronze PVD</p> <p>[BZ-XD] Dark Bronze PVD</p>	

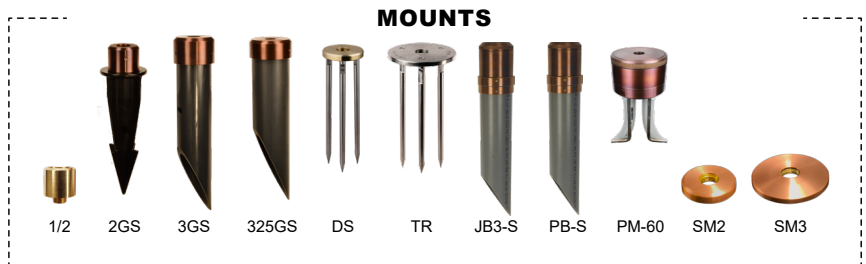

PHOTOMETRIC OVERVIEW

Information based on 6 Watts and 3000K. To download more in-depth IES photometric data, visit auroralight.com/product/lpl5-sq-giza/

Mounting Height - 2 Feet

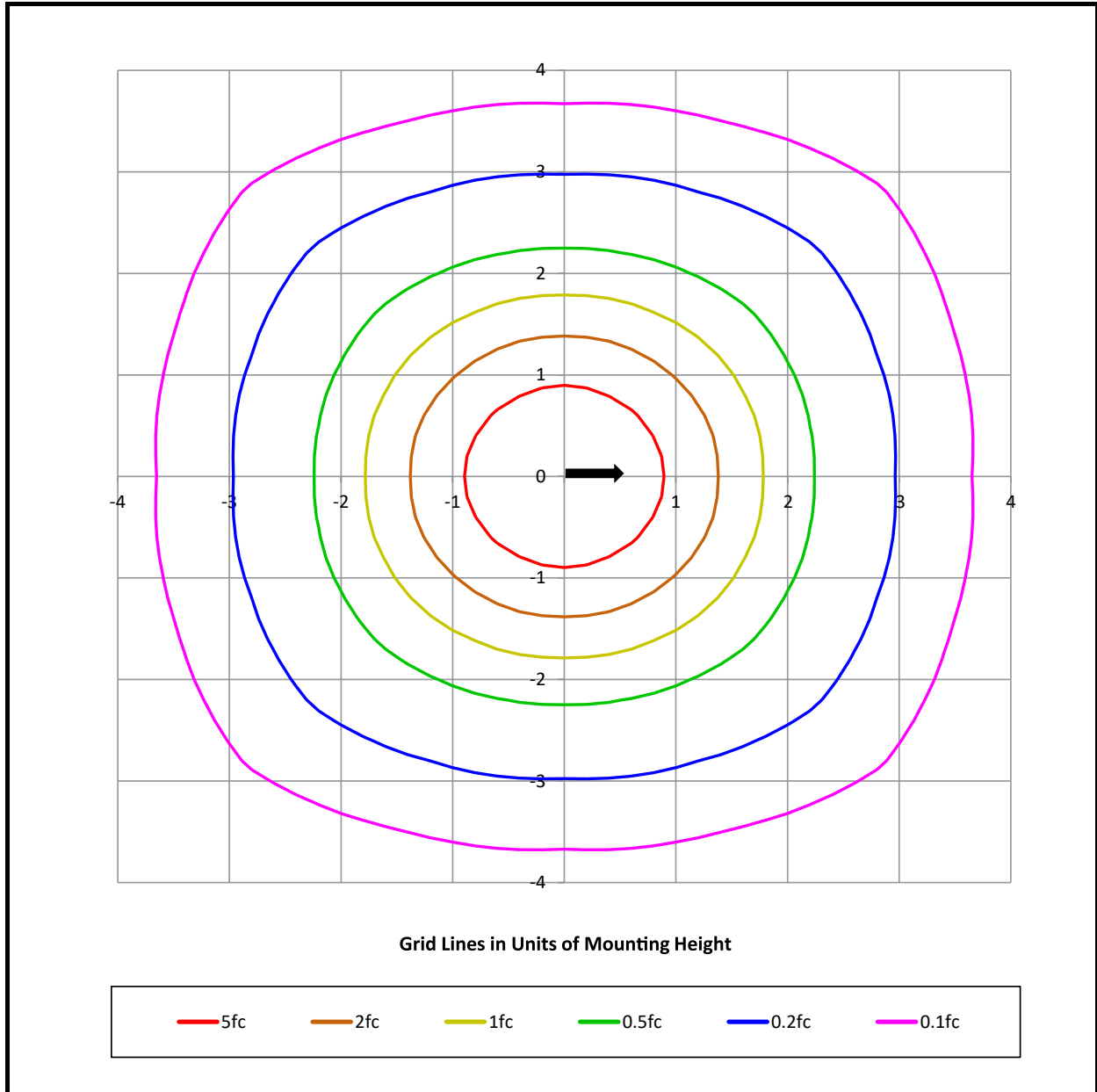

BUG Rating B0 U0 G0