



LWL3-R CENTRO



LWL3-R-BLP
Shown w/ optional [SBH] & [CHA]



LWL3-R-NAT
Shown w/ optional [SBH] & [CHA]

LWL3-R Centro; a fixed-aim, in-grade luminaire, is among the newest efforts from Auroralight. It is a small diameter, large aperture fixture that features our robust and popular LM16 Copper Core® LED module. The LM16 module is Thermally Integrated® with the solid brass bezel for superior heat dissipation allowing peak performance and long life without color shift. With a full range of light shaping accessories, this new tool is highly versatile and capable.

Features include:

- Interchangeable LED Module in 4 or 6 Watts up to 420 Lumens
- 6 Interchangeable PMMA Acrylic Optics from 20° to 75°
- 2700K (80 & 90 CRI), 3000K (80 CRI), or 4000K (80 CRI)
- Thermally Integrated® w/ Copper Core Technology®
- 12V Integral Constant Current Driver (Remote 12V AC/DC Transformer Required)
- Dimmable to <10% (TRIAC/Forward Phase) via Compatible Transformer
- Compatible w/ 12V AC/DC MLV or ELV Transformers
- Solid Brass Construction
- Drive-over Rated up to 6,000 lbs.

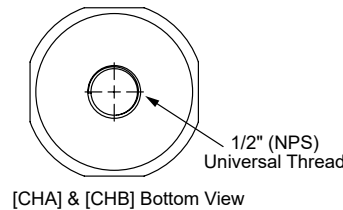
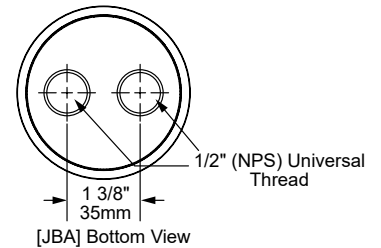
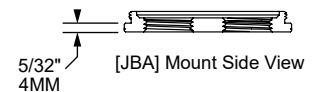
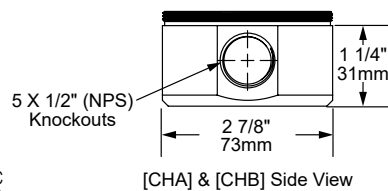
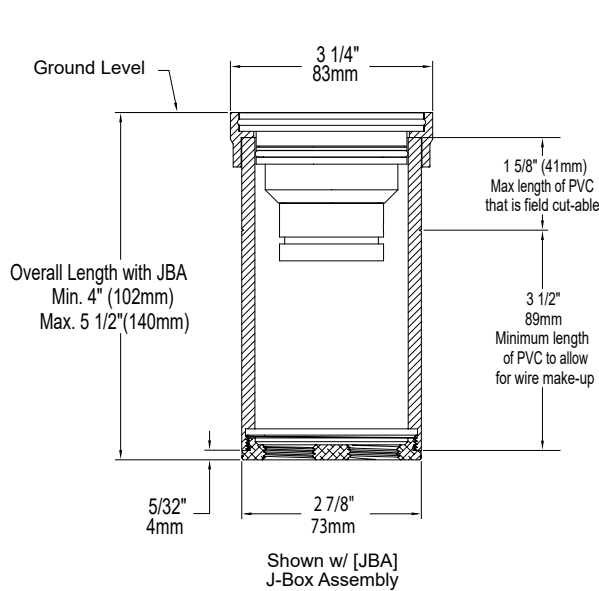

* When using CHA or CHB overall height minimum is 4" with PVC

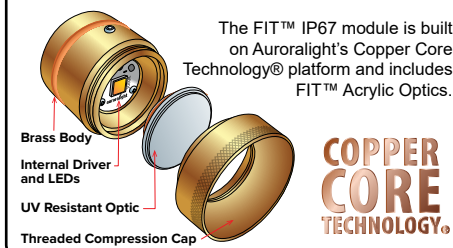

The FIT™ IP67 module is built on Auroralight's Copper Core Technology® platform and includes FIT™ Acrylic Optics.



Copper Core® is a registered trademark of Auroralight. It is synonymous with the mark of quality and integrity. It means that our products are built upon a superior foundation of Solid Copper, ensuring every critical part functions seamlessly together Thermally integrated® one component to the next. Auroralight manufactured without compromise, engineered with passion, in the USA.



SEE NEXT PAGE FOR ORDERING INFORMATION



ORDERING GUIDE: ^{Prefix} **LWL3-R** L (LED) WL (WELL LIGHT) 3 (SERIES) R (RECESSED)

☐ INDICATES REQUIRED FIELD ⋯ INDICATES OPTIONAL FIELD ✓ INCLUDED IN BASE PRICE [_] QUICK SPEC (See Below)

QUICK SPEC SKU **LWL3-R-4-W-27-SBH-JBA-NAT**

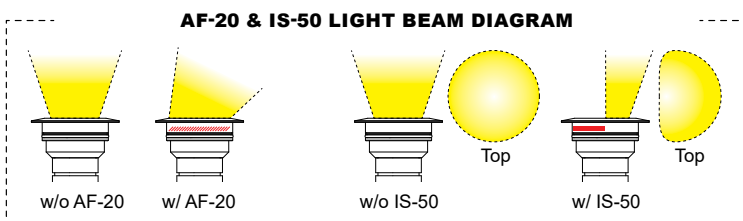
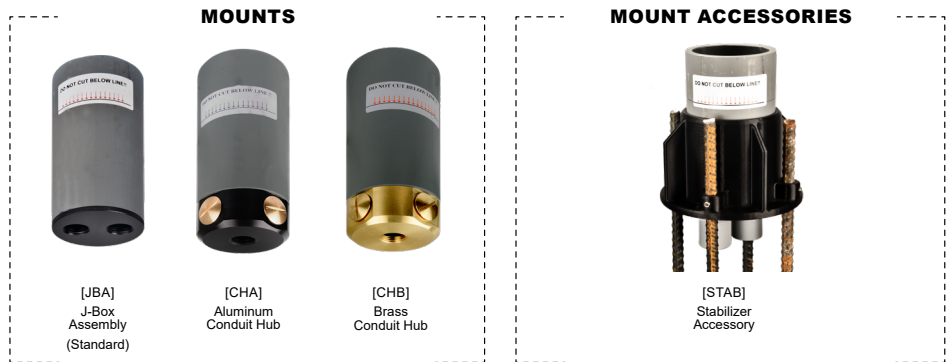
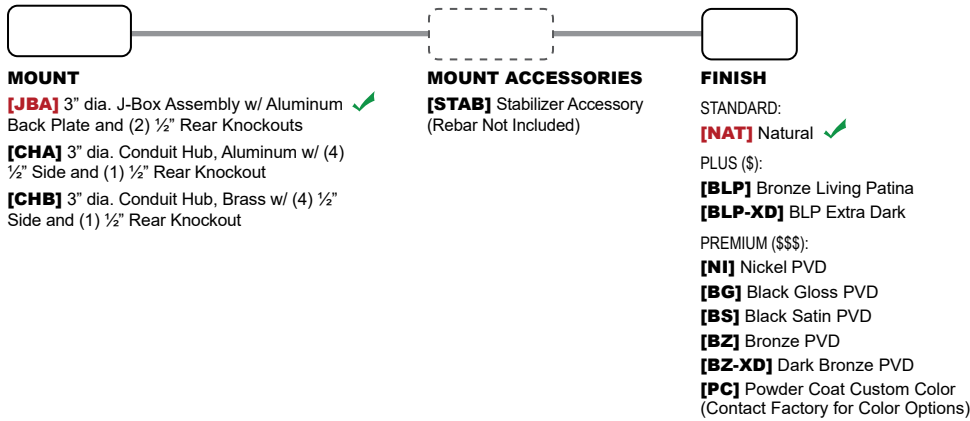
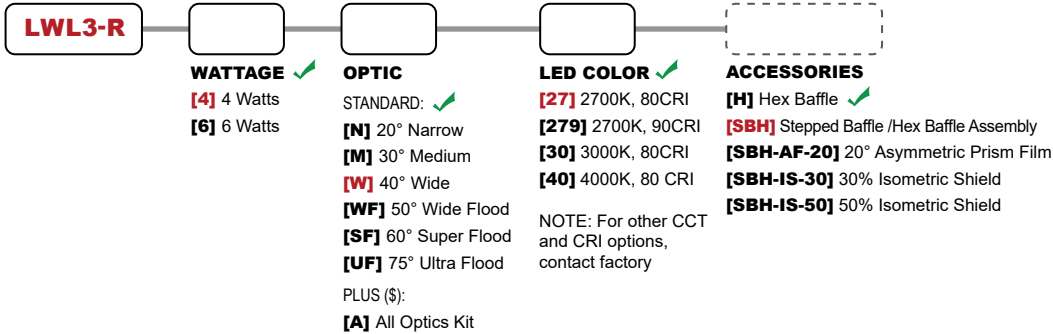

LWL3-R CENTRO

PHOTOMETRIC OVERVIEW

Information based on 3000K. To download more in-depth IES photometric data, visit auroralight.com/product/lwl3-r-centro/

6 Watts 3000K 20° (NARROW) 309.3 LUMENS • CBCP 1121 AURORALIGHT LWL3-R-6-N-30		
30 FT	1.25	10.6
26 FT	1.66	9.18
22 FT	2.32	7.77
18 FT	3.46	6.36
14 FT	5.72	4.94
10 FT	11.2	3.53
6 FT	31.1	2.12
Distance From Fixture	Footcandles	Beam Width

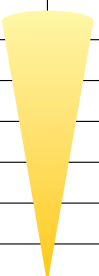

6 Watts 3000K 30° (MEDIUM) 355.6 LUMENS • CBCP 1159 AURORALIGHT LWL3-R-6-M-30		
30 FT	1.23	12.7
26 FT	1.63	11.0
22 FT	2.28	9.31
18 FT	3.41	7.61
14 FT	5.63	5.92
10 FT	11.0	4.23
6 FT	30.7	2.54
Distance From Fixture	Footcandles	Beam Width



6 Watts 3000K 40° (WIDE) 420.6 LUMENS • CBCP 865 AURORALIGHT LWL3-R-6-W-30		
30 FT	0.961	19.9
26 FT	1.28	17.3
22 FT	1.79	14.6
18 FT	2.67	12.0
14 FT	4.41	9.30
10 FT	8.65	6.64
6 FT	24.0	3.99
Distance From Fixture	Footcandles	Beam Width

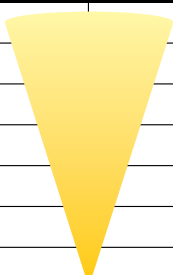

6 Watts 3000K 50° (WIDE FLOOD) 389.4 LUMENS • CBCP 507 AURORALIGHT LWL3-R-6-WF-30		
30 FT	0.558	26.5
26 FT	0.742	23.0
22 FT	1.04	19.4
18 FT	1.55	15.9
14 FT	2.56	12.4
10 FT	5.02	8.84
6 FT	13.9	5.30
Distance From Fixture	Footcandles	Beam Width



6 Watts 3000K 60° (SUPER FLOOD) 346.0 LUMENS • CBCP 330 AURORALIGHT LWL3-R-6-SF-30		
30 FT	0.361	31.5
26 FT	0.481	27.3
22 FT	0.672	23.1
18 FT	1.00	18.9
14 FT	1.66	14.7
10 FT	3.25	10.5
6 FT	9.03	6.30
Distance From Fixture	Footcandles	Beam Width

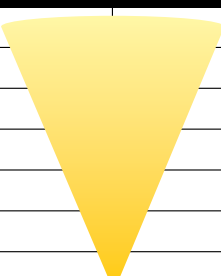

6 Watts 3000K 75° (ULTRA FLOOD) 263.0 LUMENS • CBCP 217 AURORALIGHT LWL3-R-6-UF-30		
30 FT	0.234	37.0
26 FT	0.311	32.1
22 FT	0.435	27.1
18 FT	0.649	22.2
14 FT	1.07	17.3
10 FT	2.10	12.3
6 FT	5.84	7.40
Distance From Fixture	Footcandles	Beam Width

