



DLX16-ACS MARINER

The **DLX16 Mariner** pendant paired with our exclusive Aurora Catenary System (ACS) is the perfect selection to illuminate plazas, courtyards, and intimate patio areas beautifully. Choose from 4 attractive shroud options to match your aesthetic. Optimized for drop-in MR16 LED lamps for ease of serviceability or customers who prefer LED retrofit lamps as their LED solution.

Fixture features include:

- Variety of MR16 Lamp Options
- Solid Brass Construction
- Also available with Non-Catenary Hanging and Ridgid mount options (See DLX16-HL)

Catenary features include:

- Pre-assembled System for Easy Installation
- Catenary Cable up to 1/4" dia. accepted (by other)
- Cable Brake System™ prevents luminaire slippage
- Solid C3600 Billet Brass Construction

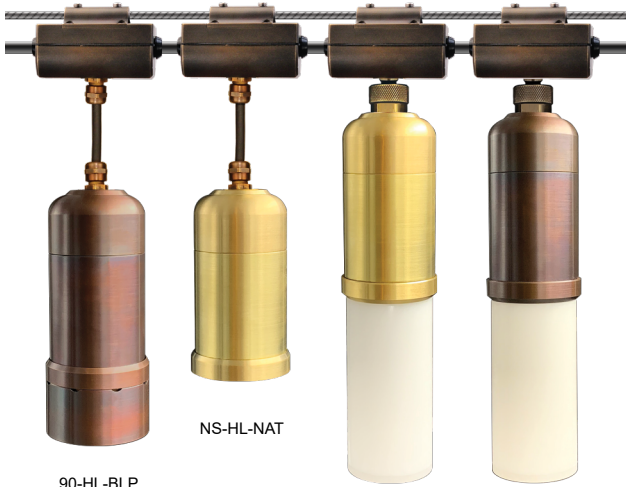

90-HL-BLP

NS-HL-NAT

AC4-RM-NAT

AC4-RM-BLP

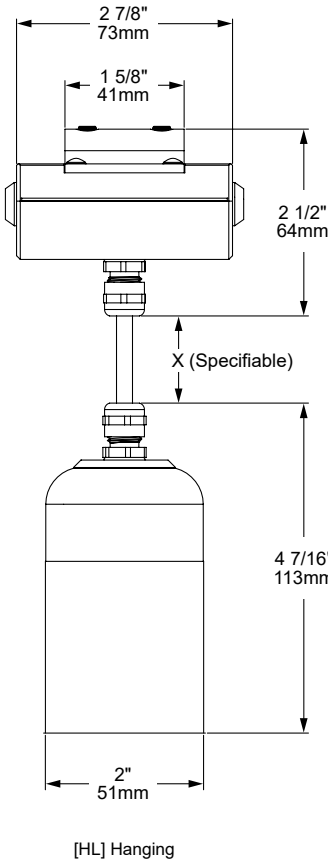

[HL] Hanging

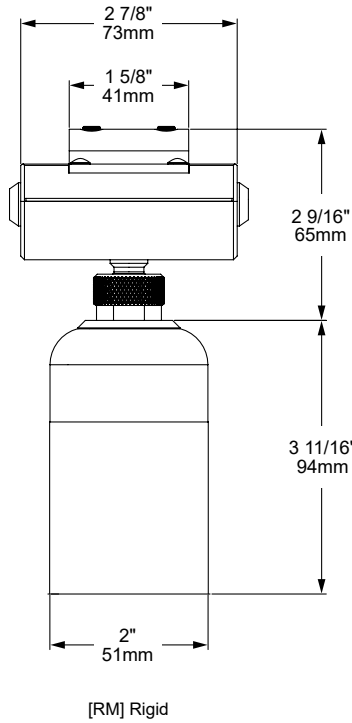

[RM] Rigid

Accepts 1/8", 3/16" or 1/4" cable. (Cable and Engineering by Others)

Outdoor Rated Cable. (by Auroralight)

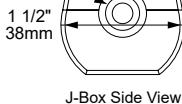

J-Box Side View

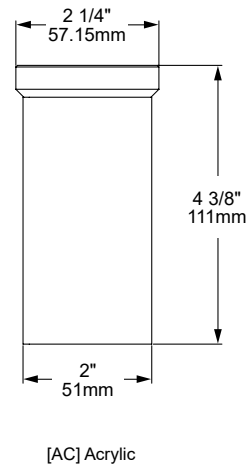

[AC] Acrylic

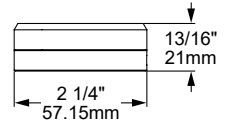

[NS] No Shield

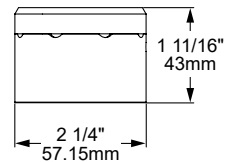

[90] 90° Straight Shield

DOWNLOAD OUR ACS DESIGN GUIDE TO START BUILDING YOURS TODAY

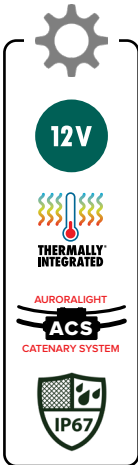

SEE NEXT PAGE FOR ORDERING INFORMATION

DLX16-ACS MARINER

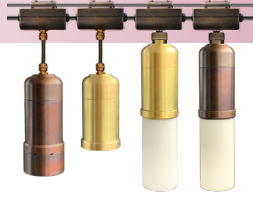

Prefix

ORDERING GUIDE: **DLX16-ACS** DL (DOWN LIGHT) X (NO LAMP) 16 (SERIES) ACS (AURORA CATENARY SYSTEM)

INDICATES REQUIRED FIELD INDICATES OPTIONAL FIELD INCLUDED IN BASE PRICE [_] QUICK SPEC (See Below)

QUICK SPEC SKU **DLX16-ACS-90-7-W-27-H-HL-NAT**

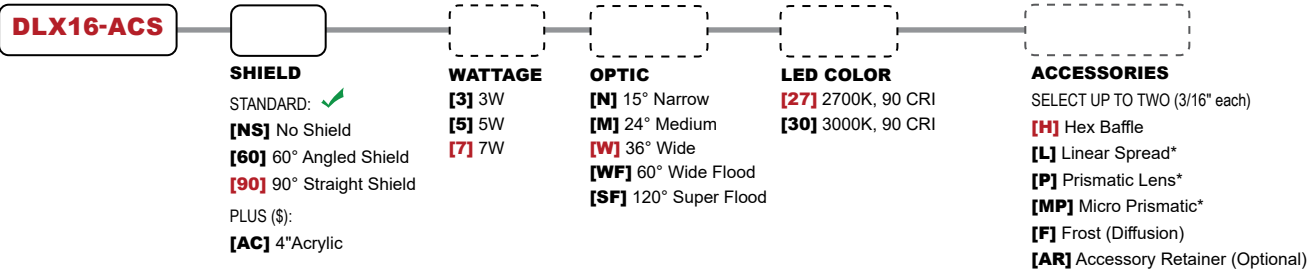

* Limit ONE when AR is selected

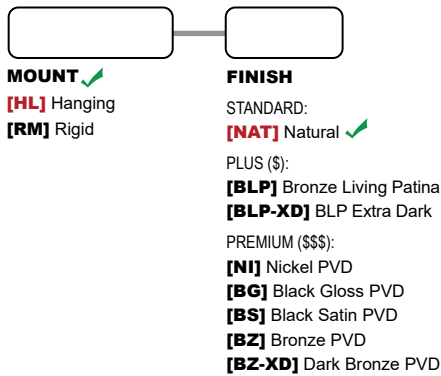

ACCESSORIES

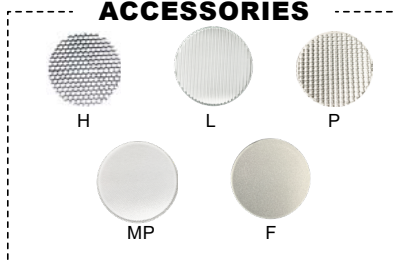

MOUNTS

