



LPL1-BLP-XD

The newly updated **LPL1 Centinela** is a low-energy, high-performance LED path light. Its stylish, contemporary design and slim profile allow it to blend seamlessly into the surrounding landscape. New is a larger stem for enhanced durability and a re-designed optical system for superior light distribution. The LPL1 exclusively from Auroralight is unrivaled in quality or performance.



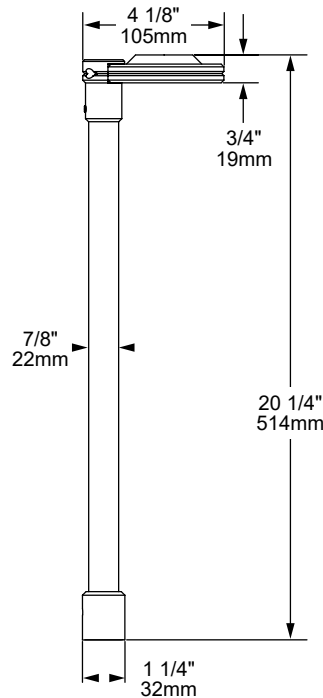

Features include:

- 3 Watts, up to 179 Lumens
- Cree LED™ XP-L® XP-L
- 2700K (80 & 90 CRI), 3000K (80 CRI), 4500K (80 CRI) or Amber 585-595nm
- Thermally Integrated® and Field Serviceable LED Module
- 12V Integral Driver, Dimmable to <10% typ.
- Compatible w/ 12V AC/DC ELV or MLV Transformers
- Recommended Spacing 10–18' O.C.
- Solid Copper and Brass Construction
- Contact Factory for Custom Height



COPPER CORE TECHNOLOGY®

Copper Core® is a registered trademark of Auroralight. It is synonymous with the mark of quality and integrity. It means that our products are built upon a superior foundation of Solid Copper, ensuring every critical part functions seamlessly together Thermally integrated® one component to the next. Auroralight manufactured without compromise, engineered with passion, in the USA.

- 
- 
- 
- 
- 
- 

SEE NEXT PAGE FOR ORDERING INFORMATION

LPL1 CENTINELA



ORDERING GUIDE: ^{Prefix} **LPL1** L (LED) PL (PATH LIGHT) 1 (SERIES)

INDICATES REQUIRED FIELD INDICATES OPTIONAL FIELD INCLUDED IN BASE PRICE [_] QUICK SPEC (See Below)

QUICK SPEC SKU **LPL1-27-2GS-NAT**

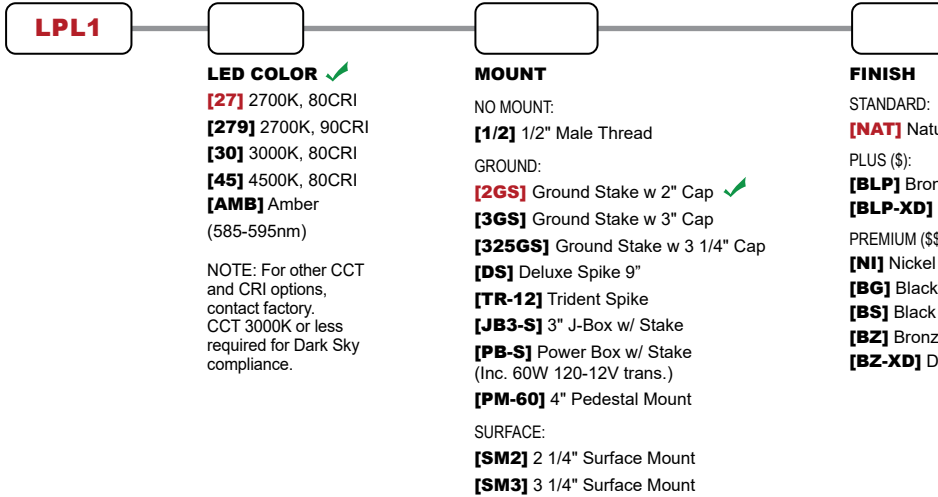

MOUNTS



LPL1 CENTINELA

PHOTOMETRIC OVERVIEW

To download more in-depth IES photometric data, visit auroralight.com/product/lpl1-centinela/

Mounting Height - 2 Feet

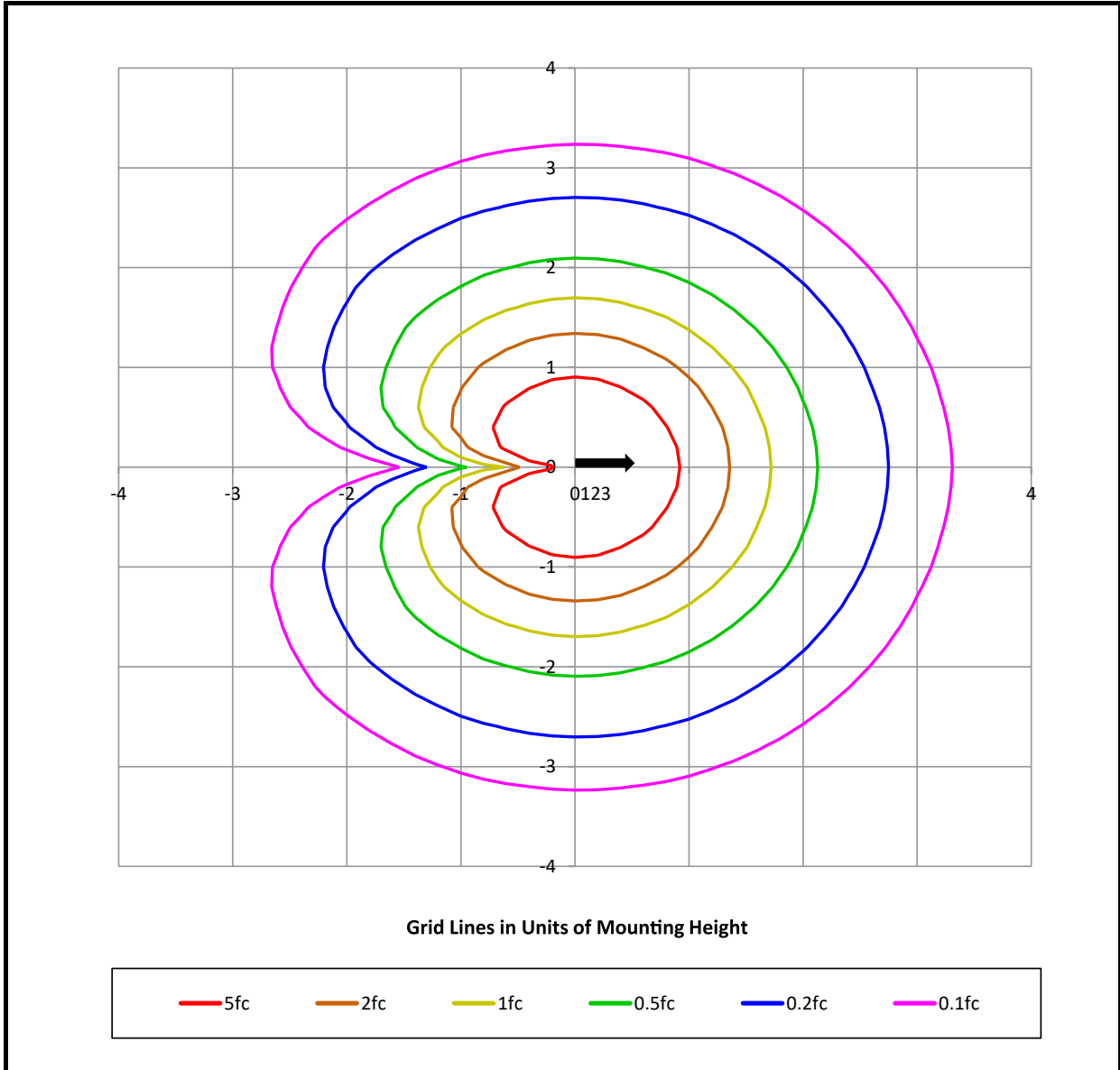

BUG Rating B0 U0 G0