

AURORALIGHT

REQUIRED TOOLS:

Wire Cutter / Stripper
1-7/16" Hole Saw (wood) or Core Drill (masonry)
Phillips Head Screw Driver

SONOMA INSTALL GUIDE (Wood or Stone)

IGR035001 / IGR035102 / IGR035203 / IGR035304 / IGR035402

INSTRUCTIONS:

1. To prevent electrical shock, disconnect transformer from electrical supply and make sure power supply is completely off before installation. Fixtures should always be installed by a licensed electrician.
2. Remove the **faceplate assembly** from the **can assembly** by sliding it out. Disconnect the **18GA lead wire** from the **wago wire connectors**.
3. If installing a 1/2" conduit adapter into the back of the **can assembly**, remove the **black plug** and thread it in.
4. Prepare a 1-7/16" to 1-1/2" hole, 5" deep in the desired location. Make hole deeper if more room is needed for wire connectors.
5. Prepare the drill holes by using the **flange** on the **can assembly** as a template. If mounting in wood, drill 1/16" pilot holes for the **#6 wood screws**. If stone, drill holes for the provided screw anchors.
6. Separate the 2-conductor **18GA lead wire** on the backside by stripping the larger insulation then strip about 1/2" of the insulation off ends of the individual wires (see figure).
7. Connect the **18GA lead wires** to the **main supply cable** using **UL listed wire connectors** suitable for the location (if using conduit, pull **main supply cable** through the **can assembly**).
8. Use the provided screws and/or anchors to fasten the **can assembly** down to the **mounting surface** (see figure).
9. Reconnect the **18GA lead wires** to the **wago connectors**, place the wires and connectors inside the **can assembly** (if using conduit, connect **main supply cable** to **wago connectors**) then slide the **faceplate assembly** in until it stops.

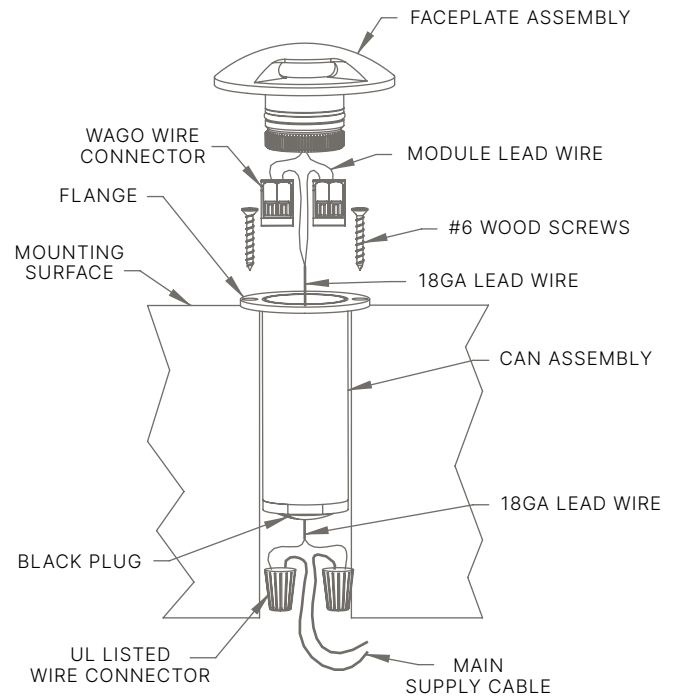

TIP: Small gauge cable is vulnerable to damage in the landscape; Protect by routing in close proximity to the luminaire or adjacent to concrete slab or similar structure. Do not over tighten.

P. 760.931.2910

E. techsupport@auroralight.com

O. 2742 Loker Ave. W Carlsbad CA 92010

W. www.auroralight.com

WARNING: Luminaire must be installed in accordance with local codes and the National Electrical Code (NEC). Failure to do so may result in serious injury and or damage to the luminaire.

WARNING: Risk of electric shock. Install per NEC Code 680.22(B (6), if listed low voltage luminaires are to be located near a pool, spa or fountain.

AURORALIGHT

REQUIRED TOOLS:

Wire Cutter / Stripper

SONOMA INSTALL GUIDE (Landscape)

IGR035001 / IGR035102 / IGR035203 / IGR035304 / IGR035402

INSTRUCTIONS:

1. To prevent electrical shock, disconnect transformer from electrical supply and make sure power supply is completely off before installation. Fixtures should always be installed by a licensed electrician.
2. Remove the **faceplate assembly** from the **can assembly** by sliding it out. Disconnect the **18GA lead wire** from the **wago wire connectors**.
3. If installing a 1/2" conduit adapter into the back of the **can assembly**, remove the **black plug** and thread it in.
4. Prepare a hole approximately 4" wide and 5" deep.
5. Fill the bottom of the hole with **pea gravel** or sand for water drainage and a secure base. Lightly pack it down in the hole.
6. Connect the **18GA lead wire** coming out of the **Black plug** to **12GA underground supply cable** using **UL listed connectors** suitable for underground burial or wet location (if using conduit, pull **main supply cable** through the **can assembly**).
7. Place the **can assembly** in the prepared hole and back fill the area around the fixture with **pea gravel** or sand to secure in place. Fill any remaining area with soil until the **flange** is the only thing visible.
8. Reconnect the wires at the **wago connectors**, place the wires and connectors inside the **can assembly**, then slide the **faceplate assembly** in until it stops.

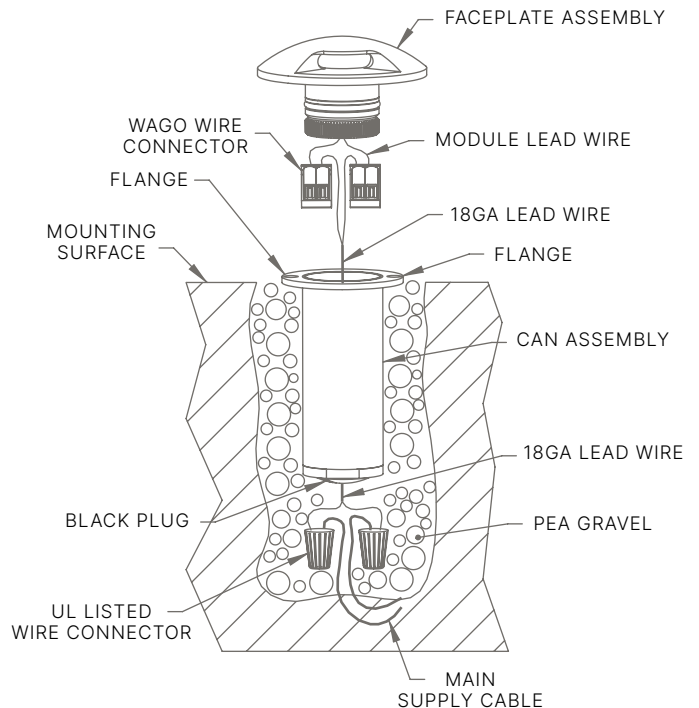

TIP: Small gauge cable is vulnerable to damage in the landscape; protect by routing in close proximity to the luminaire or adjacent to concrete slab or similar structure. Do not over tighten.

P. 760.931.2910

E. techsupport@auroralight.com

O. 2742 Loker Ave. W Carlsbad CA 92010

W. www.auroralight.com

WARNING: Luminaire must be installed in accordance with local codes and the National Electrical Code (NEC). Failure to do so may result in serious injury and or damage to the luminaire.

WARNING: Risk of electric shock. Install per NEC Code 680.22(B (6), if listed low voltage luminaires are to be located near a pool, spa or fountain.

AURORALIGHT

REQUIRED TOOLS:

Wire Cutter / Stripper

SONOMA INSTALL GUIDE (Concrete)

IGR035001 / IGR035102 / IGR035203 / IGR035304 / IGR035402

INSTRUCTIONS:

1. To prevent electrical shock, disconnect transformer from electrical supply and make sure power supply is completely off before installation. Fixtures should always be installed by a licensed electrician.
2. Remove the **faceplate assembly** from the **can assembly** by sliding it out. Disconnect the **main supply cable** from the **wago wire connectors**.
3. Secure the **can assembly** to the **wire conduit** and use other methods if necessary to ensure it doesn't move during the concrete pour. The bottom of the **flange** should be at the desired **concrete surface** level (see figure).
4. Pull the **main supply cable** into the **can assembly**, leave enough slack to make the wire connection outside of it.
5. Plug the open top of the **can assembly** to ensure no wet concrete enters into it during the concrete pour. The top of the **flange** needs to be free of any concrete slag as well.
6. Pour the concrete and let it cure.
7. Connect the **main supply cable** to the **module lead wire** using the **wago wire connectors**, place the connectors and excess wire in the **can assembly**, then slide the **faceplate assembly** down inside of it until flush with surface.

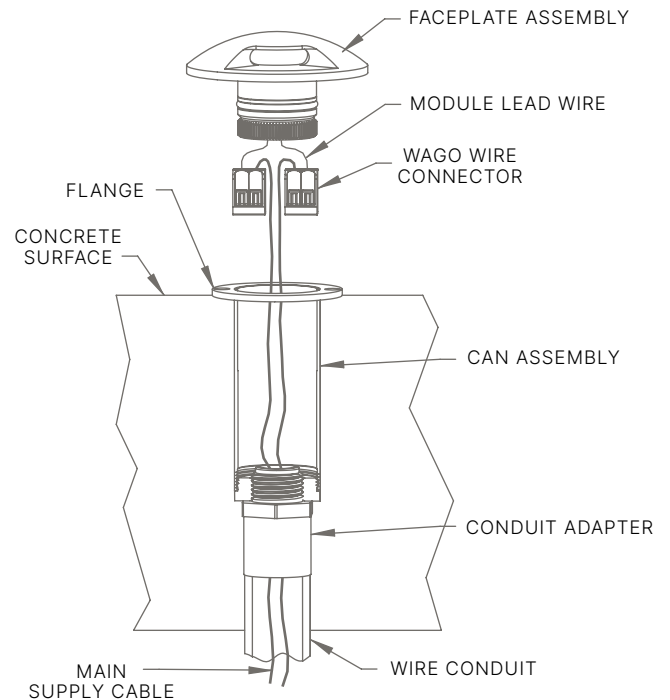

TIP: Small gauge cable is vulnerable to damage in the landscape; Protect by routing in close proximity to the luminaire or adjacent to concrete slab or similar structure. Do not over tighten.

P. 760.931.2910

E. techsupport@auroralight.com

O. 2742 Loker Ave. W Carlsbad CA 92010

W. www.auroralight.com

WARNING: Luminaire must be installed in accordance with local codes and the National Electrical Code (NEC). Failure to do so may result in serious injury and or damage to the luminaire.

WARNING: Risk of electric shock. Install per NEC Code 680.22(B (6), if listed low voltage luminaires are to be located near a pool, spa or fountain.