

# AURORALIGHT

## REQUIRED TOOLS:

Wire Cutter / Stripper  
1-7/16" Hole Saw (wood) or Core Drill (masonry)  
Phillips Head Screw Driver

## SONOMA INSTALL GUIDE (Wood or Stone)

IGR035001 / IGR035102 / IGR035203 / IGR035304 / IGR035402

### INSTRUCTIONS:

1. To prevent electrical shock, disconnect transformer from electrical supply and make sure power supply is completely off before installation. Fixtures should always be installed by a licensed electrician.
2. Remove the **faceplate assembly** from the **can assembly** by sliding it out. Disconnect the **18GA lead wire** from the **wago wire connectors**.
3. If installing a 1/2" conduit adapter into the back of the **can assembly**, remove the **black plug** and thread it in.
4. Prepare a 1-7/16" to 1-1/2" hole, 5" deep in the desired location. Make hole deeper if more room is needed for wire connectors.
5. Prepare the drill holes by using the **flange** on the **can assembly** as a template. If mounting in wood, drill 1/16" pilot holes for the **#6 wood screws**. If stone, drill holes for the provided screw anchors.
6. Separate the 2-conductor **18GA lead wire** on the backside by stripping the larger insulation then strip about 1/2" of the insulation off ends of the individual wires (see figure).
7. Connect the **18GA lead wires** to the **main supply cable** using **UL listed wire connectors** suitable for the location (if using conduit, pull **main supply cable** through the **can assembly**).
8. Use the provided screws and/or anchors to fasten the **can assembly** down to the **mounting surface** (see figure).
9. Reconnect the **18GA lead wires** to the **wago connectors**, place the wires and connectors inside the **can assembly** (if using conduit, connect **main supply cable** to **wago connectors**) then slide the **faceplate assembly** in until it stops.

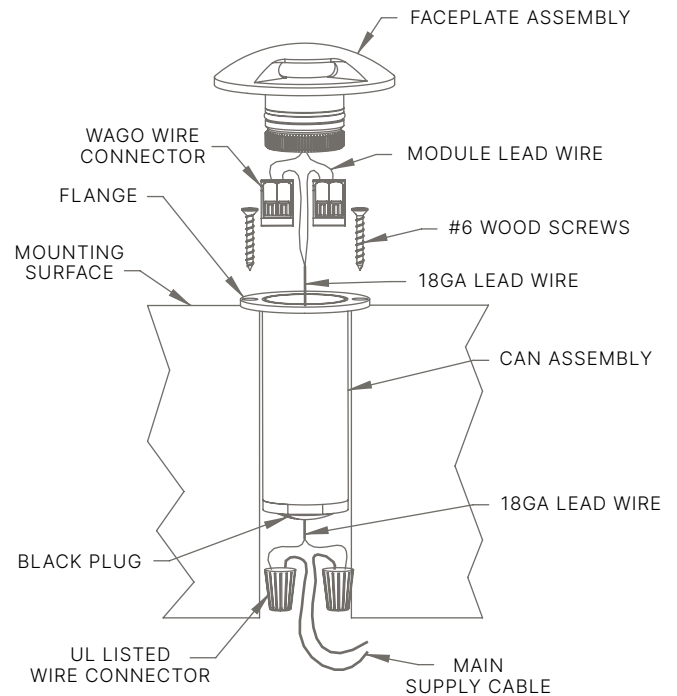

**TIP:** Small gauge cable is vulnerable to damage in the landscape; Protect by routing in close proximity to the luminaire or adjacent to concrete slab or similar structure. Do not over tighten.

P. 760.931.2910

E. techsupport@auroralight.com

O. 2742 Loker Ave. W Carlsbad CA 92010

W. www.auroralight.com

**WARNING:** Luminaire must be installed in accordance with local codes and the National Electrical Code (NEC). Failure to do so may result in serious injury and or damage to the luminaire.

**WARNING:** Risk of electric shock. Install per NEC Code 680.22(B (6), if listed low voltage luminaires are to be located near a pool, spa or fountain.

# AURORALIGHT

REQUIRED TOOLS:

Wire Cutter / Stripper

## SONOMA INSTALL GUIDE (Landscape)

IGR035001 / IGR035102 / IGR035203 / IGR035304 / IGR035402

### INSTRUCTIONS:

1. To prevent electrical shock, disconnect transformer from electrical supply and make sure power supply is completely off before installation. Fixtures should always be installed by a licensed electrician.
2. Remove the **faceplate assembly** from the **can assembly** by sliding it out. Disconnect the **18GA lead wire** from the **wago wire connectors**.
3. If installing a 1/2" conduit adapter into the back of the **can assembly**, remove the **black plug** and thread it in.
4. Prepare a hole approximately 4" wide and 5" deep.
5. Fill the bottom of the hole with **pea gravel** or sand for water drainage and a secure base. Lightly pack it down in the hole.
6. Connect the **18GA lead wire** coming out of the **Black plug** to **12GA underground supply cable** using **UL listed connectors** suitable for underground burial or wet location (if using conduit, pull **main supply cable** through the **can assembly**).
7. Place the **can assembly** in the prepared hole and back fill the area around the fixture with **pea gravel** or sand to secure in place. Fill any remaining area with soil until the **flange** is the only thing visible.
8. Reconnect the wires at the **wago connectors**, place the wires and connectors inside the **can assembly**, then slide the **faceplate assembly** in until it stops.

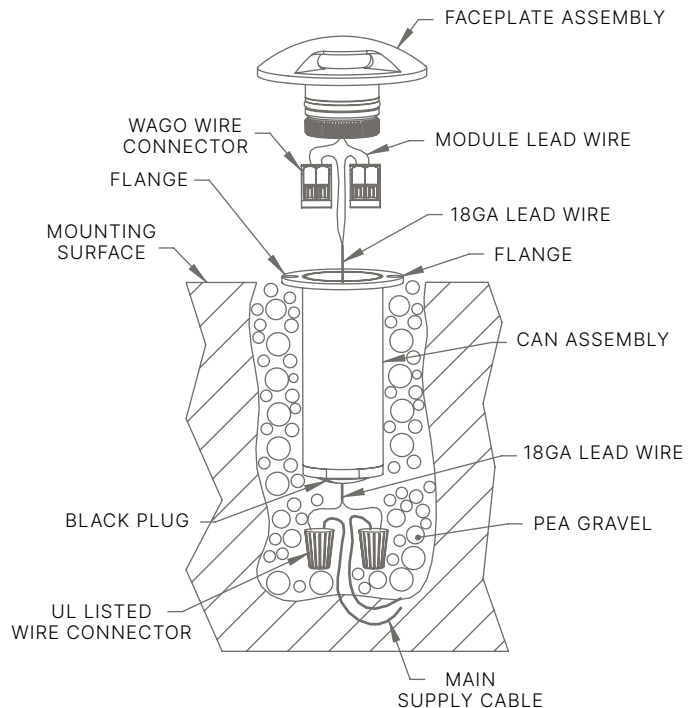

**TIP:** Small gauge cable is vulnerable to damage in the landscape; Protect by routing in close proximity to the luminaire or adjacent to concrete slab or similar structure. Do not over tighten.

P. 760.931.2910

E. techsupport@auroralight.com

O. 2742 Loker Ave. W Carlsbad CA 92010

W. www.auroralight.com

**WARNING:** Luminaire must be installed in accordance with local codes and the National Electrical Code (NEC). Failure to do so may result in serious injury and or damage to the luminaire.

**WARNING:** Risk of electric shock. Install per NEC Code 680.22(B (6), if listed low voltage luminaires are to be located near a pool, spa or fountain.

# AURORALIGHT

REQUIRED TOOLS:

Wire Cutter / Stripper

## SONOMA INSTALL GUIDE (Concrete)

IGR035001 / IGR035102 / IGR035203 / IGR035304 / IGR035402

### INSTRUCTIONS:

1. To prevent electrical shock, disconnect transformer from electrical supply and make sure power supply is completely off before installation. Fixtures should always be installed by a licensed electrician.
2. Remove the **faceplate assembly** from the **can assembly** by sliding it out. Disconnect the **main supply cable** from the **wago wire connectors**.
3. Secure the **can assembly** to the **wire conduit** and use other methods if necessary to ensure it doesn't move during the concrete pour. The bottom of the **flange** should be at the desired **concrete surface** level (see figure).
4. Pull the **main supply cable** into the **can assembly**, leave enough slack to make the wire connection outside of it.
5. Plug the open top of the **can assembly** to ensure no wet concrete enters into it during the concrete pour. The top of the **flange** needs to be free of any concrete slag as well.
6. Pour the concrete and let it cure.
7. Connect the **main supply cable** to the **module lead wire** using the **wago wire connectors**, place the connectors and excess wire in the **can assembly**, then slide the **faceplate assembly** down inside of it until flush with surface.

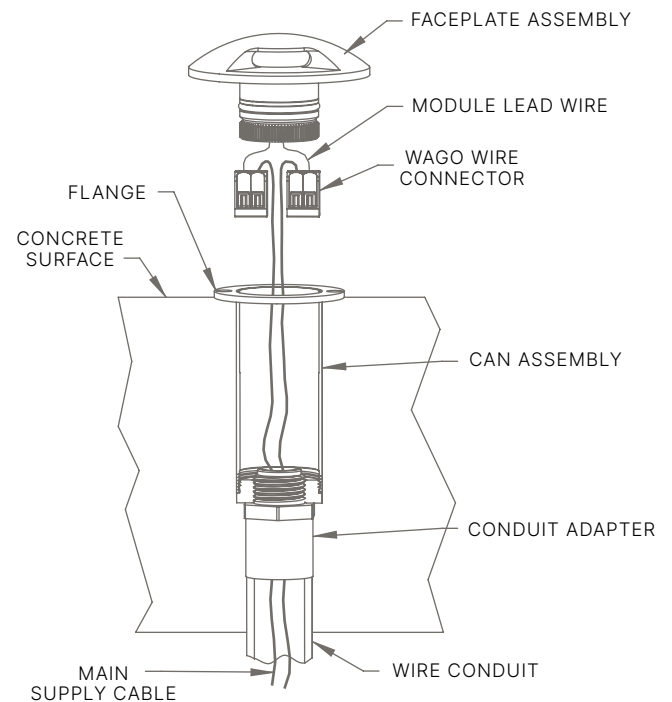

**TIP:** Small gauge cable is vulnerable to damage in the landscape; Protect by routing in close proximity to the luminaire or adjacent to concrete slab or similar structure. Do not over tighten.

P. 760.931.2910

E. techsupport@auroralight.com

O. 2742 Loker Ave. W Carlsbad CA 92010

W. www.auroralight.com

**WARNING:** Luminaire must be installed in accordance with local codes and the National Electrical Code (NEC). Failure to do so may result in serious injury and or damage to the luminaire.

**WARNING:** Risk of electric shock. Install per NEC Code 680.22(B (6), if listed low voltage luminaires are to be located near a pool, spa or fountain.